

CONTACT ANALYSIS

1.Introduction

Contact problems are highly nonlinear and usually require significant computing effort. For this reason, it is important to understand the physical side of the problem in order to build an effective numerical model. Two fundamental problems occur:

- the contact zone is not precisely known and depends, among others, on factors such as load, material properties, boundary conditions; contacting surfaces of the bodies come into contact and lose it in a manner that is difficult to predict.
- friction is an additional factor in introducing non-linearity, and can sometimes cause problems with the convergence of the iterative process.

There are two classes of contact problems: contact between a rigid body and elastic body (*rigid-to-flexible*) and the contact between elastic bodies (*flexible-to-flexible*). For problems where there is a large disproportion between the rigidity of bodies in contact, it is advisable to use rigid-to-flexible contact-type. Examples of such tasks are the tasks of metal forming. The second class of problems, flexible-to-flexible, occurs in the case of contact bodies of a similar value of Young's modulus. You should then take into account the vulnerability of all the bodies in contact.

There are five mechanisms of contact: node-to-node contact type, node-to-surface contact type, surface-to-surface contact type, line- to-line and line-surface contact type. Each type uses a different set of contact elements.

It is important to define a potential contact zone represented by the edge nodes or elements associated with the boundary surface of the body. The computational model recognizes the possible contact pairs for special items, which are built in the area.

1.1. The idea of creating elements of the contact zone in node-to-segment contact

The idea of creating elements of the contact zone is shown on the example of two-dimensional node-to-segment contact.

Consider the contact of two bodies: A is the body that is contactable, B - the target of the contact (Fig. 1). The decision, which body has to be contactor or target is arbitrary and has consequences that will be discussed later.

Two bodies in contact

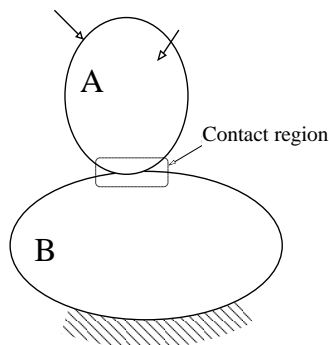

Contact region

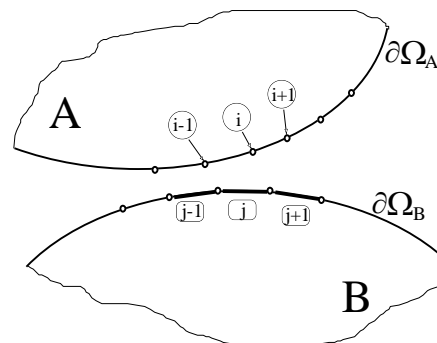

Fig.1. Contact of two bodies

The way of getting into contact and the formation of a new element is shown in Figure 2.

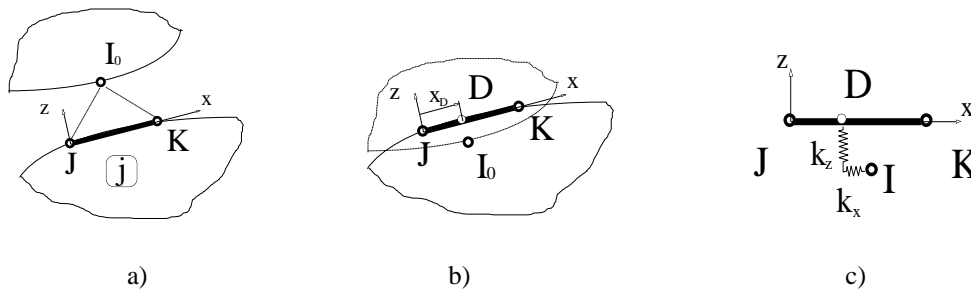

Fig.2. The phases of contacting: a) near contact, b) contact is closed, c) contact element.

1.2. Contact Kinematics for surface-to-surface elements

Contact Pair

In studying the contact between two bodies, the surface of one body is conventionally taken as a contact surface and the surface of the other body as a target surface. For rigid-flexible contact, the contact surface is associated with the deformable body; and the target surface must be the rigid surface. For flexible-flexible contact, both contact and target surfaces are associated with deformable bodies. The contact and target surfaces constitute a "Contact Pair".

The contact element is associated with the 3-D target segment elements using a shared real constant set number. This element is located on the surface of 3-D solid, shell elements (called underlying element). It has the same geometric characteristics as the underlying elements. The contact surface can be either side or both sides of the shell or beam elements.

In surface-to-surface contact elements, the contact detection points are the integration points and are located either at nodal points or Gauss points. The contact element is constrained against penetration into the target surface at its integration points. However, the target surface can, in principle, penetrate through into the contact surface. See Figure 3.

Contact element uses Gauss integration points by default, which generally provides more accurate results than when using the nodes themselves as the integration points. A disadvantage of using nodal contact points is that, for a uniform pressure, the kinematically equivalent forces at the nodes are unrepresentative and indicate release at corners.

Penetration Distance

The penetration distance is measured along the normal direction of the contact surface (at integration points) to the target surface

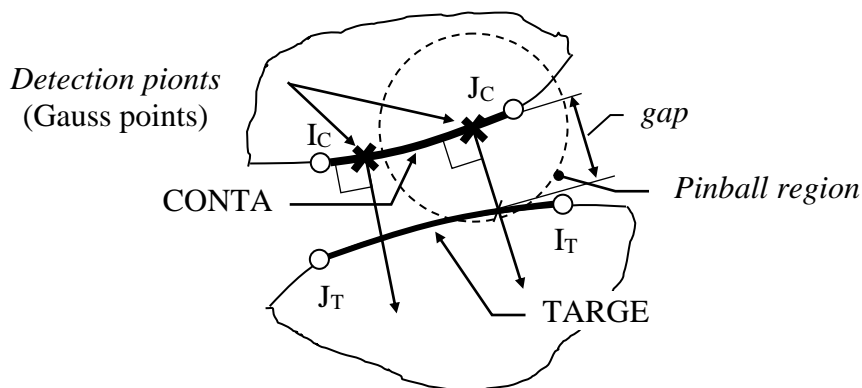

Fig.3. Surface-to-surface contact

Pinball Algorithm

The position and the motion of a contact element relative to its associated target surface determine the contact element status. The program monitors each contact element and assigns a status:

STAT = 0 Open far-field contact

STAT = 1 Open near-field contact

STAT = 2 Sliding contact

STAT = 3 Sticking contact

A contact element is considered to be in near-field contact when the element enters a pinball region, which is centered on the integration point of the contact element. The computational cost of searching for contact depends on the size of the pinball region. Far-field contact element calculations are simple and add few computational demands.

The near-field calculations (for contact elements that are nearly or actually in contact) are slower and more complex. The most complex calculations occur the elements are in actual contact.

Setting a proper pinball region is useful to overcome spurious contact definitions if the target surface has several convex regions. The current default setting should be appropriate for most contact problems.

1.3. Frictional Model

In the basic Coulomb friction model, two contacting surfaces can carry shear stresses. When the equivalent shear stress is less than a limit frictional stress, no motion occurs between the two surfaces. This state is known as sticking.

1.4. Contact Algorithm

Four different contact algorithms are implemented.

Pure Penalty Method

This method requires both contact normal and tangential stiffness. The main drawback is that the amount penetration between the two surfaces depends on this stiffness. Higher stiffness values decrease the amount of penetration but can lead to ill-conditioning of the global stiffness matrix and to convergence difficulties. Ideally, you want a high enough stiffness that contact penetration is acceptably small, but a low enough stiffness that the problem will be well-behaved in terms of convergence or matrix ill-conditioning.

Augmented Lagrangian Method

The augmented Lagrangian method is an iterative series of penalty updates to find the Lagrange multipliers (i.e., contact tractions). Compared to the penalty method, the augmented Lagrangian method usually leads to better conditioning and is less sensitive to the magnitude of the contact stiffness coefficient. However, in some analyses, the augmented Lagrangian method may require additional iterations, especially if the deformed mesh becomes excessively distorted.

Pure Lagrange Multiplier Method

The pure Lagrange multiplier method does not require contact stiffness. Instead it requires chattering control parameters. Theoretically, the pure Lagrange multiplier method enforces zero penetration when contact is closed and "zero slip" when sticking contact occurs. However the pure Lagrange multiplier method adds additional degrees of freedom to the model and requires additional iterations to stabilize contact conditions. This will increase the

computational cost. This algorithm has chattering problems due to contact status changes between open and closed or between sliding and sticking. The other main drawback of the Lagrange multiplier method is overconstraint in the model. The model is overconstrained when a contact constraint condition at a node conflicts with a prescribed boundary condition on that degree of freedom (e.g., D command) at the same node. Overconstraints can lead to convergence difficulties and/or inaccurate results. The Lagrange multiplier method also introduces zero diagonal terms in the stiffness matrix, so that iterative solvers (e.g., PCG) can not be used.

Lagrange Multiplier on Contact Normal and Penalty on Frictional Direction

In this method only the contact normal pressure is treated as a Lagrange multiplier. The tangential contact stresses are calculated based on the penalty method. This method allows only a very small amount of slip for a sticking contact condition. It overcomes chattering problems due to contact status change between sliding and sticking which often occurs in the pure Lagrange Multiplier method. Therefore this algorithm treats frictional sliding contact problems much better than the pure Lagrange method.

1.5. Steps of the typical contact analysis using

It is a special tool called Contact Wizard to create the contact elements: (**Preprocessor>Modeling>Create>Contact Pair>Contact Wizard**). Contact Wizard guides the user through the process of creation of the the elements in the contact zone, automatically selecting the necessary parameters such as contact stiffness (normal and tangential), the acceptable range of penetration, etc.

The Contact Manager Toolbar provides an intuitive interface for the creation and management of contact pairs. The manager supports surface-to-surface contact analysis, node-to-surface contact analysis, and the internal multipoint constraint (MPC) method of contact.

The basic steps of the construction and analysis of the model are:

- 1) the creation of a geometric model of the object and the finite element mesh,
- 2) determination of the contact zone,
- 3) an indication of the surface "in contact" (*in which nodes are capable of coming into contact*) and the contact-target (*where the edges of the elements are liable to come into contact*)
- 4) define the target surface (Target)
- 5) define the contact surface (Contact)
- 6) setting if necessary options,
- 7) set boundary conditions,
- 8) define the solutions and steps option load
- 9) the solution to the problem,
- 10) review the results.

2. Problem to be solved

Solve the task of the steel cylindrical roller compressed between two steel facings.

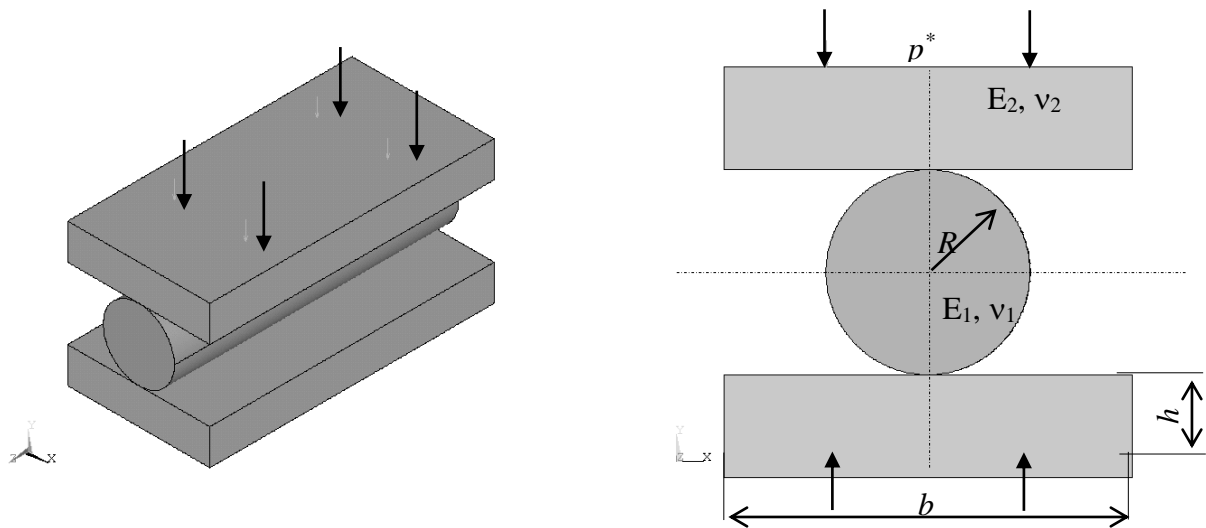

Fig.4. Cylindrical roller compressed between two steel facings

Data:

$R=10\text{mm}$, $h=20\text{mm}$, $b=80\text{mm}$, $E=2 \cdot 10^5 \text{ MPa}$, $\nu = 0,3$, $p^*=10\text{MPa}$

This problem can be reduced to the typical tasks of the elastic contact between the roller and the elastic half-space. In cross-section the system operates in a plain strain. According to Hertz models for this case we have (Figure 5):

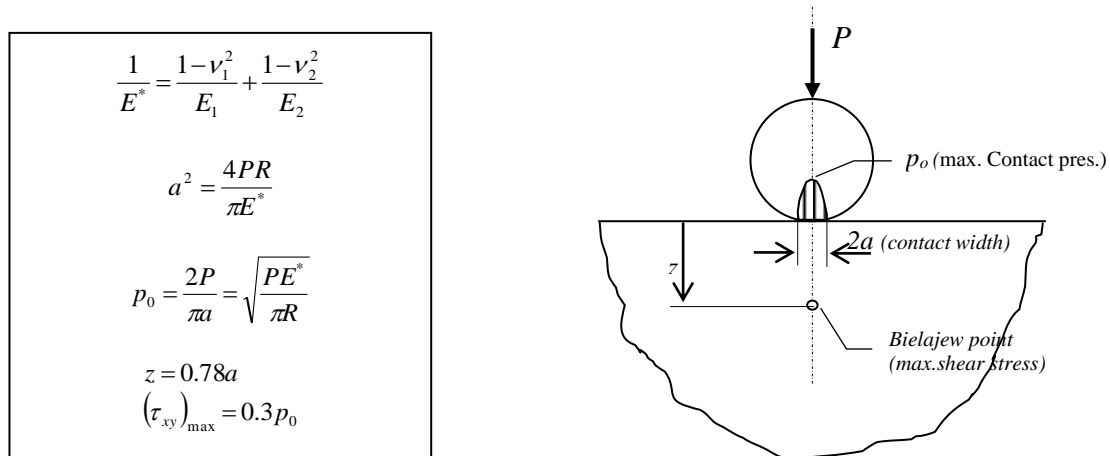

Fig.5. Solution of the Hertz problem

For the assumed data ($R=10\text{mm}$, $P=p^* \cdot b=800 \text{ N/mm}$, $E_1=E_2=2 \cdot 10^5 \text{ N/mm}^2$, $\nu = 0.3$) formulae of Fig.4 give the following results:

$E^*=1,099 \cdot 10^5 \text{ N/mm}^2$, $a = 0,3044 \text{ mm}$, $p_0=1673 \text{ N/mm}^2$, $z = 0,2374 \text{ mm}$, $\tau_{\max} = 502 \text{ N/mm}^2$

The obtained numerical results are shown in the following figures (Fig.6, 7, 8) in the form of the stress distribution and charts.

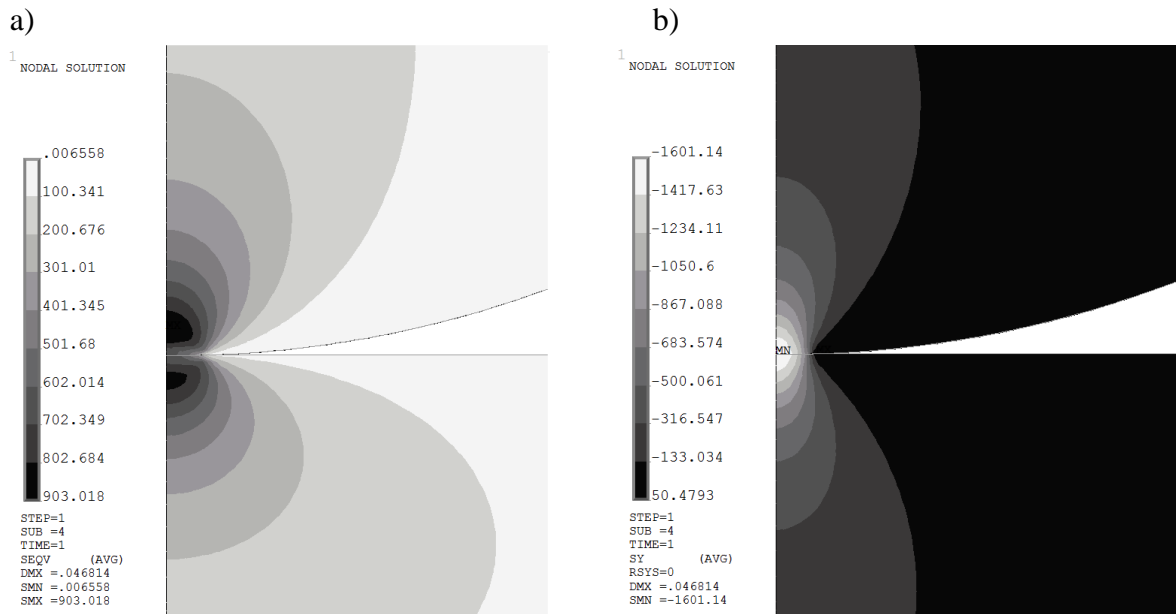

Fig.6. Stress distribution in contact zone: a) Von Mises stress, b) normal stress in Y

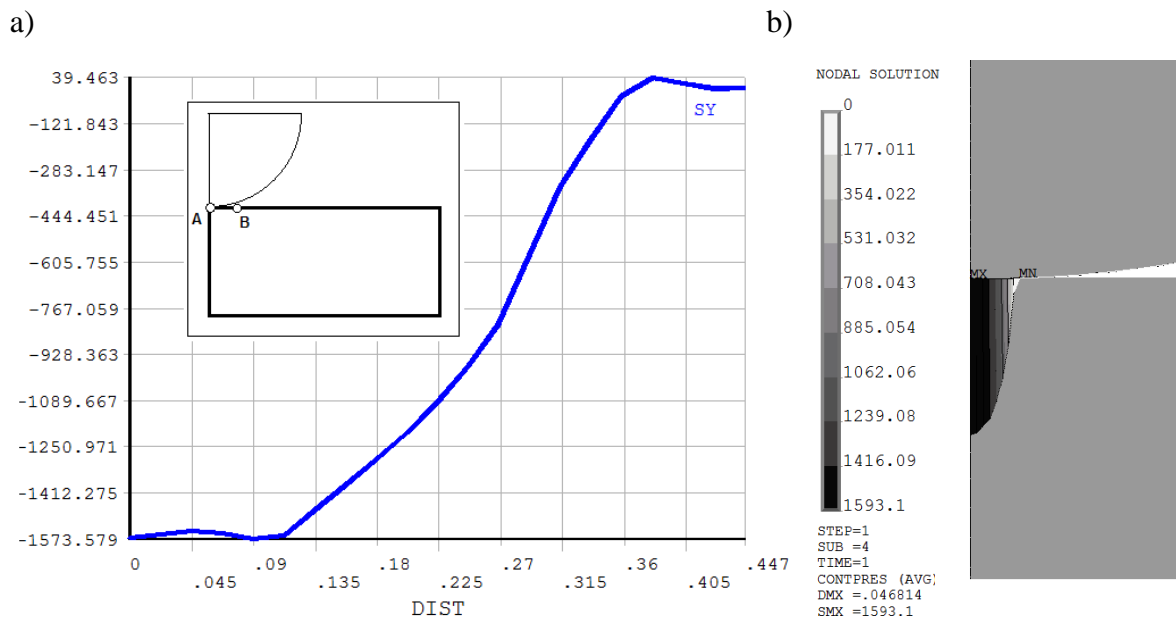

Fig.7. Stress distribution in contact zone: a) SY stress along AB path, b) pressure in contact elements

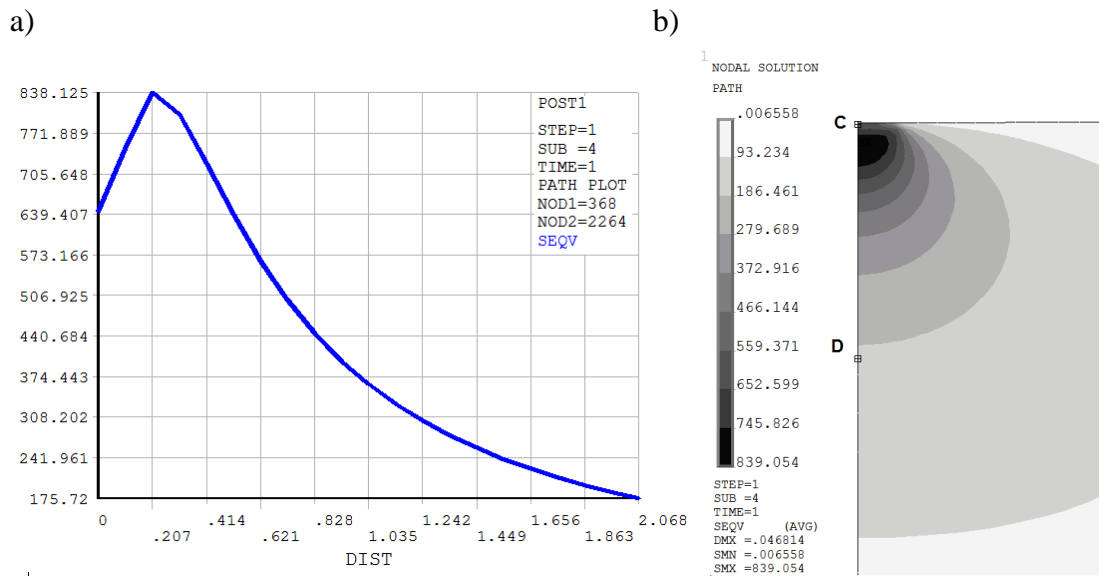

Fig.8. Distribution of Von Mises stress along contact zone: a) along CD path, b) in the steel facing

3. Numerical solution

3.1. Preprocessor

- A. Defining the geometry of the 1/4 model (using the model's double symmetry).
- B. Defining the mechanical properties
- C. Selecting the element type and indicating the plane strain behavior
- D. Meshing. Providing the appropriate mesh density in the contact zone (Figure 8). It is beneficial if the contact part (usually the more convex part) is denser than the target part.

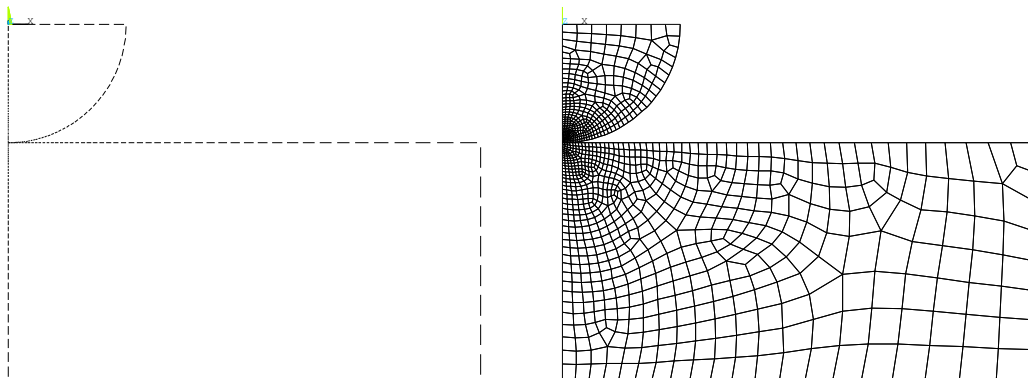

Fig.9. Solid model and FE mesh in the problem

E. Generation of contact elements

We will use this special tool to fully automate the construction of the contact zone - the so-called Contact Wizard (Fig.10).

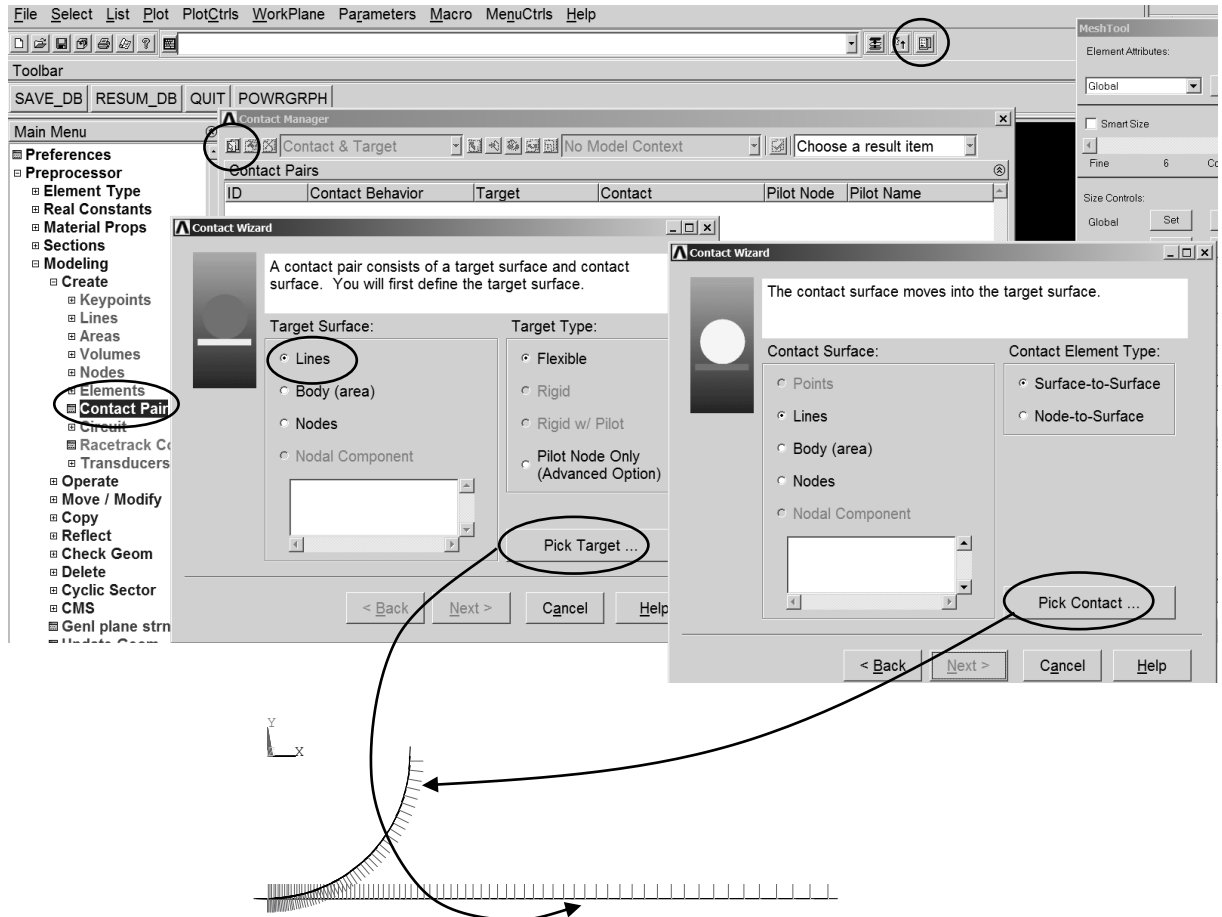

Fig.10. Generation of contact elements using Contact Wizard

It should be noted that the program itself determines the contact parameters, but sometimes they may be insufficient. To control and possibly modify parameters such as contact stiffness or penetration tolerance, open the Optional Settings window (Fig. 11). Too low contact stiffness ("too soft") or too high penetration tolerance leads to better convergence, but the results may vary (large contact area and low pressure values). Using excessive contact stiffness tolerance or too low penetration tolerance can lead to serious convergence problems.

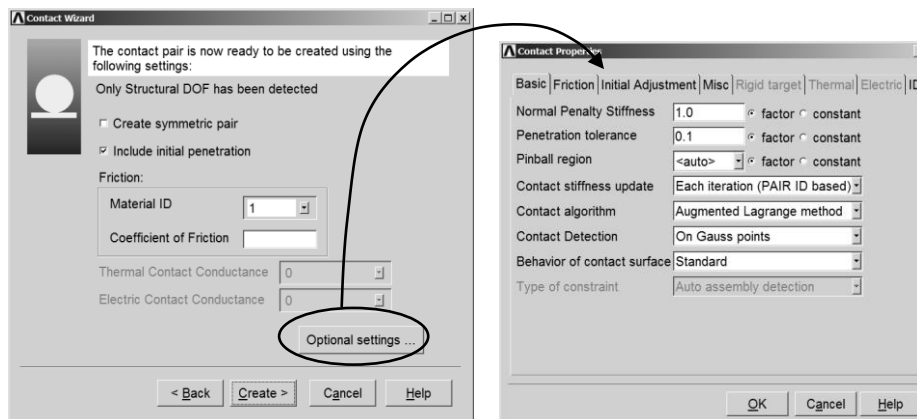

Fig.11. Setting contact parameters in Contact Properties window

3.2. Solution

- A. Introduction of boundary conditions
- B. Setting the solution options. You can use on the automatic load control or control the process yourself, keeping in mind that the load should be applied in a gentle way in the first phase of the process (Fig.12)

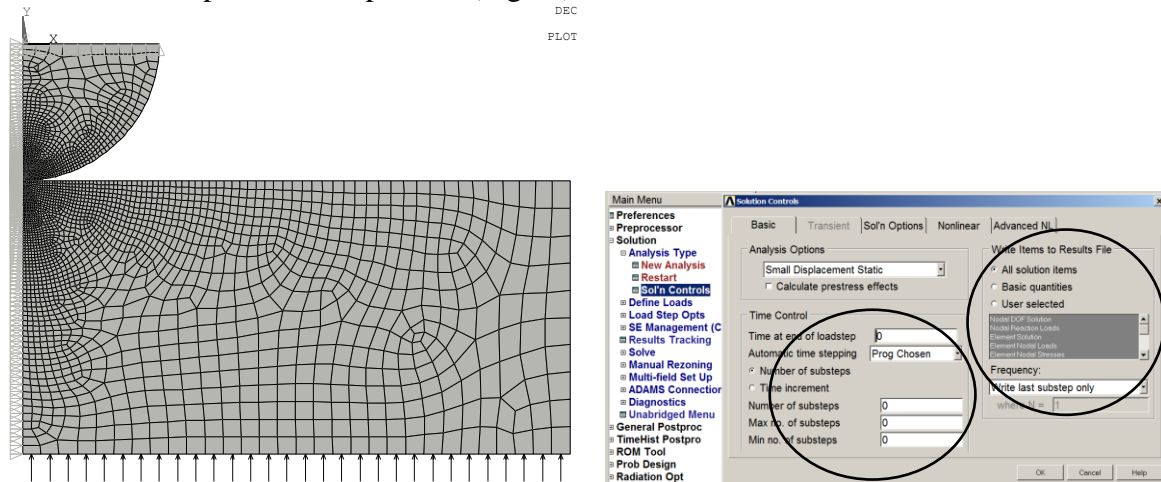

Fig.12. Introducing boundary conditions and setting load options

- C. Solving the problem

3.3. General postprocessor

The results should be presented in the form of maps and charts. Sample results are shown in Fig. 6, 7, 8.

4. Interpretation of results. Tasks to be performed

1. Solve 2D model for two different mesh densities in the contact zone, using 8-noded PLANE183 elements (note: be sure to generate elements of the contact zone again in each case). In each case, determine the pressure on the contact surface and define the width of the contact zone. Locate the Belayev point.
2. Carry out a similar analysis using 4-noded PLANE182 elements.
3. Solve the task for different materials: roller - steel ($E_1=2 \cdot 10^5 \text{ MPa}$, $\nu_1=0,3$), aluminum lining ($E_2=7 \cdot 10^4 \text{ MPa}$, $\nu_2=0,32$).
4. Perform the task with the option of *axial symmetry*, which corresponds to a problem of a ball compressed between two circular plates. Compared the results with the corresponding formulas for the Hertz solution.
5. Solve initial model using elastic-plastic material model. Assume that the roller is made of steel and is elastic, and the cladding are made of steel with a yield strength $\sigma_Y=300\text{MPa}$ (without strain hardening). Solve the problem assuming that the load p * changes gradually from 0 to 15MPa. Present the results for intermediate substeps load (eg. 5, 10, 15 MPa).
6. Solve initial model assuming friction (take the case $\mu=0.15$, $\mu=0.30$). How the friction influences the results?